

pH/ORP Controller

Supmea

Headquarters

5th floor, Building 4, Singapore Hangzhou Science Technology Park,
No. 6 street, Hangzhou Economic Development Area,
Hangzhou 310018, China

Singapore / Philippines

✉ info@supmea.com

🌐 www.supmea.com

Supmea Automation Co., Ltd.

Preface

Thank you for purchasing pH/ORP controller. Please read this manual carefully before operating and using it correctly to avoid unnecessary losses caused by false operation.

Note

- Modification of this manual's contents will not be notified as a result of some factors, such as function upgrading.
- We try our best to guarantee that the manual content is accurate, if you find something wrong or incorrect, please contact us.
- This product is forbidden to use in explosion-proof occasions.

Version

U-PH2.3-MYEN1

Safety Precautions

In order to use this product safely, be sure to follow the safety precautions described.

About this manual

- Please submit this manual to the operator for reading.
- Please read the operation manual carefully before applying the instrument. On the precondition of full understanding.

This manual only describes the functions of the product. The company does not guarantee that the product will be suitable for a particular use by the user.

Precautions for protection, safety and modification of this product

- To ensure safe use of this product and the systems it controls, Please read carefully the operation manual and understand the correct application methods before putting into operation, to avoid unnecessary losses due to operation mistakes. If the instrument is operated in other ways not described in the manual, the protections that the instrument give may be destroyed, and the failures and accidents incurred due to violation of precautions shall not be borne by our company.
- When installing lightning protection devices for this product and its control system, or designing and installing separate safety protection circuits for this product and its control system, it needs to be implemented by other devices.
- If you need to replace parts of the product, please use the model specifications specified by the company.

-
- This product is not intended for use in systems that are directly related to personal safety. Such as nuclear power equipment, equipment using radioactivity, railway systems, aviation equipment, marine equipment, aviation equipment and medical equipment. If applied, it is the responsibility of the user to use additional equipment or systems to ensure personal safety.
 - Do not modify this product.
 - The following safety signs are used in this manual:



Hazard, if not taken with appropriate precautions, will result in serious personal injury, product damage or major property damage.



Warning: Pay special attention to the important information linked to product or particular part in the operation manual.



- Confirm if the supply voltage is in consistent with the rated voltage before operation.
- Don't use the instrument in a flammable and combustible or steam area.
- To prevent from electric shock, operation mistake, a good grounding protection must be made.
- Thunder prevention engineering facilities must be well

managed: the shared grounding network shall be grounded at is-electric level, shielded, wires shall be located rationally, SPD surge protector shall be applied properly.

- Some inner parts may carry high voltage. Do not open the square panel in the front except our company personnel or maintenance personnel acknowledged by our company, to avoid electric shock.
- Cut off electric powers before making any checks, to avoid electric shock.
- Check the condition of the terminal screws regularly. If it is loose, please tighten it before use.
- It is not allowed to disassemble, process, modify or repair the product without authorization, otherwise it may cause abnormal operation, electric shock or fire accident.
- Wipe the product with a dry cotton cloth. Do not use alcohol, benzine or other organic solvents. Prevent all kinds of liquid from splashing on the product. If the product falls into the water, please cut off the power immediately, otherwise there will be leakage, electric shock or even a fire accident.
- Please check the grounding protection status regularly. Do not operate if you think that the protection measures such as grounding protection and fuses are not perfect.
- Ventilation holes on the product housing must be kept clear to avoid malfunctions due to high temperatures, abnormal operation, shortened life and fire.
- Please strictly follow the instructions in this manual,

otherwise the product's protective device may be damaged.



- Don't use the instrument if it is found damaged or deformed at opening of package.
- Prevent dust, wire end, iron fines or other objects from entering the instrument during installation, otherwise, it will cause abnormal movement or failure.
- During operation, to modify configuration, signal output, startup, stop, operation safety shall be fully considered. Operation mistakes may lead to failure and even destruction of the instrument and controlled equipment.
- Each part of the instrument has a certain lifetime, which must be maintained and repaired on a regular basis for long-time use.
- The product shall be scrapped as industrial wastes, to prevent environment pollution.
- When not using this product, be sure to turn off the power switch.
- If you find smoke from the product, smell odor, abnormal noise, etc., please turn off the power immediately and contact the company in time.

Disclaimer

- The company does not make any guarantees for the terms outside the scope of this product warranty.
- This company is not responsible for damage to the instrument or loss of parts or unpredictable damage caused directly or indirectly by improper operation of the user.

Package contents

Number	Name	Quantity	Remarks
1	pH/ORP online controller	1	
2	Manual	1	
3	Certificate	1	

After opening the box, please confirm the package contents before starting the operation. If you find that the model and quantity are incorrect or there is physical damage in appearance, please contact us.

Contents

Chapter1 Introduction.....	1
1.1. Characteristics.....	1
1.2. Parameters.....	2
Chapter2 Installation.....	4
2.1. Instrument installation.....	4
2.2. Electrode installation.....	7
2.3. Wiring.....	8
Chapter3 Navigation keys.....	9
Chapter4 System menu & operating.....	11
4.1. Monitoring menu.....	11
4.2. Alarm Setting.....	12
4.3. Password verification menu.....	12
4.4. Main menu.....	13
Chapter5 Setting.....	15
5.1. System Setting.....	15
5.2. Signal Setting.....	17
5.3. Online calibration.....	19
5.4. Remote transmission setting.....	21
5.5. Alarm setting.....	22
5.6. Information inquiry.....	24
Chapter6 Maintenance.....	25
Chapter7 Troubleshooting.....	28

Chapter1 Introduction

This product is an instrument developed by our company for online monitoring of pH / ORP value. The data can be transmitted to the monitoring room through RS485 or 4-20mA.

The pH / ORP controller is widely used in thermal power, chemical fertilizer, metallurgy, environmental protection, pharmaceutical, biochemical, food, tap water and other industries, and it continuously monitors the pH or ORP value and temperature in the solution.

Continuous monitoring data is connected to the recorder through the transmission output to achieve remote monitoring and recording.

1.1. Characteristics

- Modular design
- Isolated transmission output, less interference
- Measure pH / ORP and temperature
- Manually/ automatically temperature compensation
- High and low alarm
- Alarm switch
- Timeout return function
- Isolated RS485 communication

1.2. Parameters

Screen size	2.8 inch monochrome LCD, Resolution: 128*64
Dimension	Overall dimension: 96mm×96mm×112mm
	Cutout dimension: 92mm×92mm
Weight	0.5Kg
Variables	pH/ORP
Measure range	pH: 0.00~14.00pH
	ORP: -1000~+1000mV
	-2000~+2000mV (Optional)
Accuracy	pH: ± 0.02 pH; ORP: ± 1 mV
Input resistance	$\geq 10^{12}\Omega$
Temperature compensation	NTC10K: -10~60°C Accuracy $\pm 0.3^\circ\text{C}$
	60~130°C Accuracy $\pm 2^\circ\text{C}$
	Range: -10~130°C Manual/Auto
Current output	Isolated, 4 ~ 20mA can be set corresponding to pH / ORP and temperature measurement range, maximum loop is 750 Ω , $\pm 0.2\%$ FS
Alarm	2channels, Pickup/Breakaway AC250V/3A, normally open

Relative humidity	10~85%RH* (No condensation)
Working temperature	0~60℃
Power supply	AC: 220V±10%, 50Hz;
	DC: 24V
Power consumption	≤5W
Storage	Temperature: -10~60℃ Relative humidity: 5~85%RH(No condensation) Altitude: <2000m

Chapter2 Installation

2.1. Instrument installation

The installation location and installation method of this product are explained. Please be sure to read this section when installing.

Installation precautions

- The instrument is panel mounted.
- Please install it at the place with good ventilation in order to prevent the internal temperature of the instrument from rising.
- Horizontal installation shall be realized as possible

The following places shall be avoided during the installation

- Do not expose direct to sunlight and near heaters.
- The location where the environment temperature exceeds 60°C during the work.
- The location where the environment humidity exceeds 85% during the work.
- The vicinity of the electromagnetic occurring sources.
- The sites with strong mechanical vibration.
- The site where the temperature is changed a lot and the moisture condensation is easily formed.
- Places with lots of lampblack, steam, moisture, dust and corrosive gas.

Installation method:

Open a 92mm × 92mm mounting hole in the product cabinet or mounting panel, the thickness of the mounting panel is 1.5mm~13mm

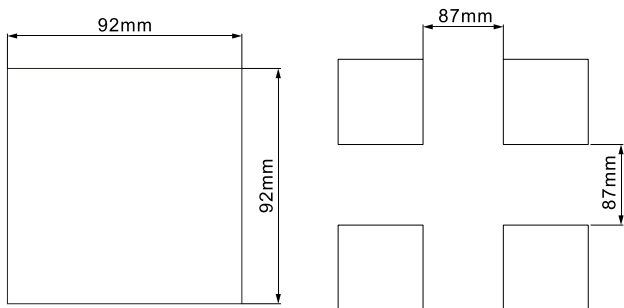

Figure 1 Mounting hole dimension drawing

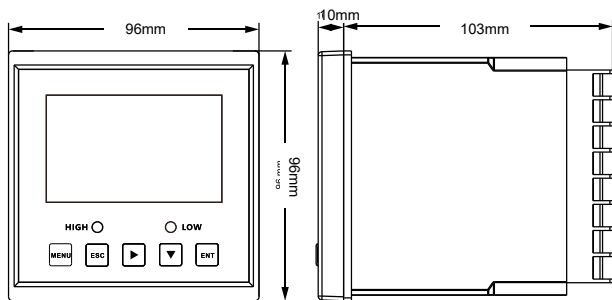

Figure 2 Dimension

Insert the product into the mounting hole fixing screw, as shown in Figure 3:

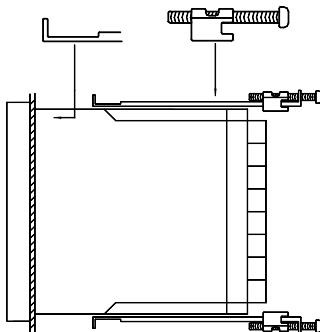

Figure 3 Installation

2.2. Electrode installation

- Schematic diagram of common installation methods

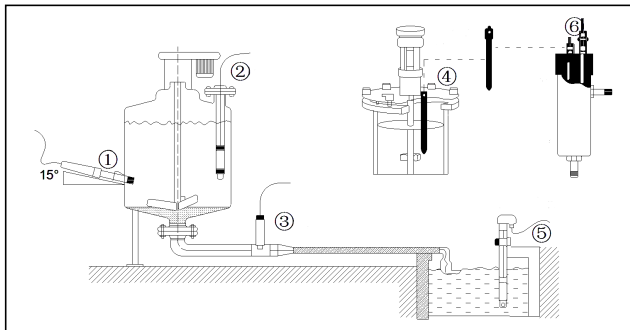

Figure 4 common installation methods

- ① Side wall installation
- ② Flange mounted at the top
- ③ Pipe installation
- ④ Top installation
- ⑤ Submersible installation
- ⑥ Flow-through installation

The interface must be in 15 oblique angle, or it will affect the normal test and use of the electrode. We won't be responsible for any results due to this.

2.3. Wiring

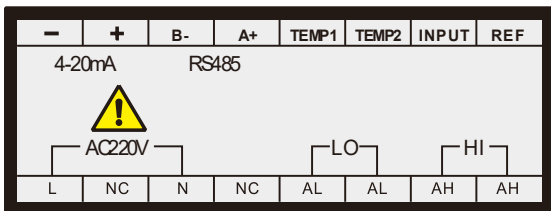

Figure5

Identification of terminal

- REF: Reference terminal of the electrode
- INPUT: Measuring terminal of the electrode
- TEMP1: Temperature compensation 1
- TEMP2: Temperature compensation 2
- RS485A+: RS485 communication interface A+
- RS485B-: RS485 communication interface B-
- NC: Unidentified
- 4~20mA+: 4~20mA output +
- 4~20mA-: 4~20mA output -
- AC220V(L): AC220V live wire
- AC220V(N): AC220V neutral wire
- LO(AL): Low alarm relay
- HI(AH): High alarm relay

Chapter3 Navigation keys

Button display

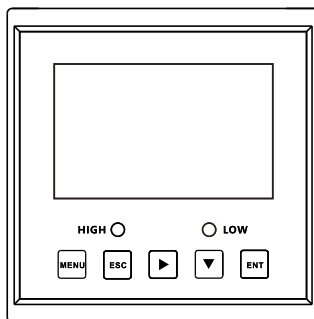





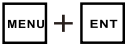



Figure 6

Definition

Sign	Button name	Key function
	Menu	Under "Monitoring page" - Enter the MENU Under "Menu page" - Exit the MENU
	Escape	Under "Monitoring page" - Alarm view Under "Menu page" - Return to the previous page Under "Calibration page" - Skip this item
	MOVE RIGHT	Make a recurrent selection of digit of parameters modify the original indication value

	<p>MOVE DOWN</p>	<p>Under "menu page" - Select the related menu Modify the values in the configuration state</p>
	<p>ENTER</p>	<p>Under "Menu page" - Enter the sub-menu or confirm modification</p>
	<p>Combination</p>	<p>Press and hold the key to enter "Temperature compensation"</p>
	<p>Combination</p>	<p>Press and hold the key to enter "Calibration"</p>
	<p>Combination</p>	<p>Press and hold the key to enter "Alarm setting"</p>

Chapter4 System menu & operating

4.1. Monitoring menu

- Press [MENU] to enter password verification page; input password to enter the home page.
- Press [ENT] to enter alarm inquiry page, to inquire the current warning configuration information.

pH monitoring page

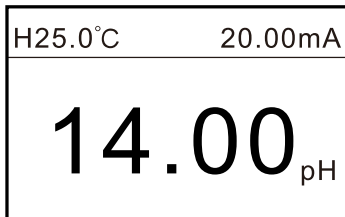

ORP monitoring page

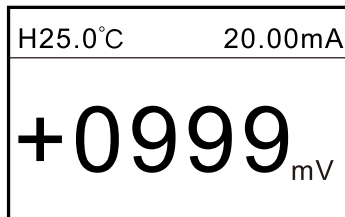

4.2. Alarm Setting

pH alarm Setting

HighPick-up : 12.00pH

HighBreakaway:11.00pH

LowPick-up : 02.00pH

LowBreakaway :03.00pH

ORP alarm Setting

HighPick-up : +0900mV

HighBreakaway:+0800mV

LowPick-up : -0900mV

LowBreakaway :-0800mV

4.3. Password verification menu

-----User Password-----

Password:0000



- Input password and Press [ENTER] to enter home page.
- Initial password is 0000, which can be modified via password modification function.
- Please contact us if you forget your password.

4.4. Main menu

-----Main Menu-----

- 1.System Setting
- 2.Signal Setting
- 3.Online Calibration
- 4.Remote Setting
- 5.Alarm Setting
- 6.Information Inquiry

- System Setting: settings of language, buzzer and backlight, modification of password and factory settings
- Signal Setting: Toggle electrode type and automatic/manual temperature compensation.
- Online Calibration: Calibrate or correct pH and ORP signal.
- Remote Setting: settings of RS485 parameters and current transmission output.
- Alarm Setting: settings of parameters of high and low warning.
- Information Inquiry: current version number.

If the button is not pressed for 3 minutes, it will automatically return to the monitoring page.

Chapter5 Setting

5.1. System Setting

-----System Setting-----

- ➡ 1.Language
- 2.Buzzer
- 3.Backlight
- 4.Change Password
- 5.Factory

Note:

- Language: language type, Chinese or English.

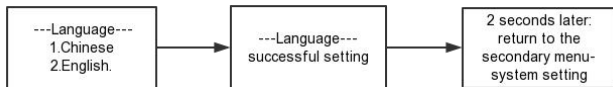

- Buzzer: settings of switch of buzzer during warning.

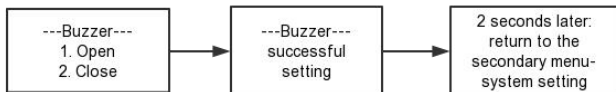

- Backlight setting: settings of LCD backlight.
- Password modification: password modification and log-in with new password.

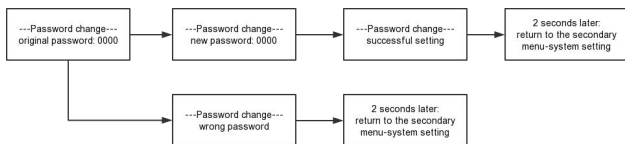

- Factory setting: return to factory settings

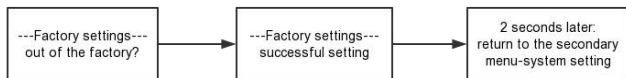

If the button is not pressed for 3 minutes, it will automatically return to the monitoring page.

5.2. Signal Setting

----- Signal Setting -----

1. Electrode Type
2. Temp Compensation
3. Fixed Value
4. Filter Time

Note:

- Electrode type: set the electrode type, pH electrode and ORP electrode two types. Temperature compensation: set the automatic warming or manual temperature compensation, the temperature range of -10-130 °C. Temp Switch: auto temperature offset NTC10K or PT1000 or manual temperature compensation, temperature range: -10°C-130.0°C.

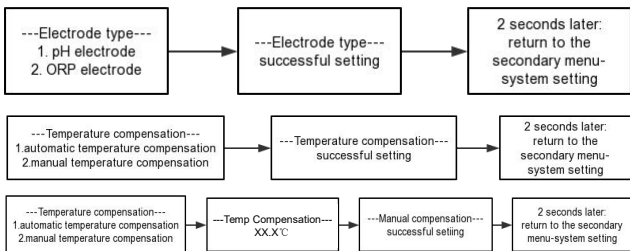

- Fixed output: set the fixed value output mode, in this mode the measured display value does not change, the current output corresponds to the output according to the set pH value, long press the confirmation key on the monitoring interface to keep the current measured value output, and exit the hold / fixed output mode You need to press the confirmation key in the monitoring interface to return to the normal monitoring state.

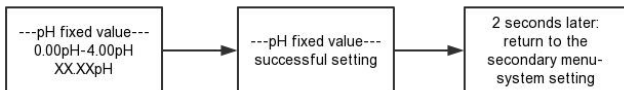

- Time: set the measurement and transmission filter time 0.1-99.9s, the greater the filter time, the slower the measurement and output value changes.

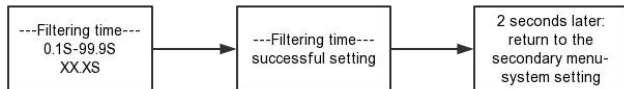

If the button is not pressed for 3 minutes, it will automatically return to the monitoring page.

5.3. Online calibration

-----Online Calibration-----

- ➡ 1.pH Calibration
- 2.pH Modification
- 3. ORP Calibration
- 4. ORP Modification

Note:

- pH Calibration: Enter the pH calibration screen, the first pH electrode into the 4.00pH standard solution, standing for a moment, to be stable after the show, press the [ENTER], then the pH electrode into the 6.86pH/7pH standard solution Set the pH electrode into the 9.18pH/10pH standard solution, put it aside for a moment, after the test is stable, press [ENTER], the display shows the success of the calibration, the whole process of pH calibration completes.

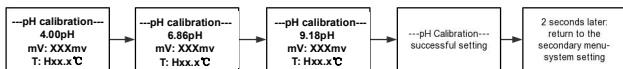

- pH Modification: The measured pH can be modified between 2 pH values. °C

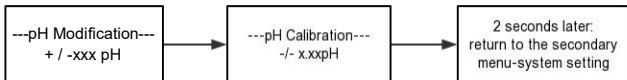

- ORP Calibration: enter the ORP calibration screen, the first ORP electrode into the 86mV standard solution, standing for a moment, to be shown after the stability, press the [ENTER], then the ORP electrode into the 256mV standard solution, static Set a moment, after the display is stable, press the [ENTER] display calibration is successful, ORP calibration process is over.

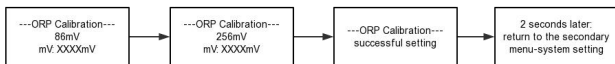

- ORP Modification: The measured ORP can be modified between 300mV.

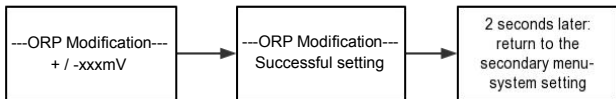

- Temperature correction: You can correct the temperature of the automatic temperature compensation; the correction range is $\pm 20.0\text{ }^{\circ}\text{C}$.

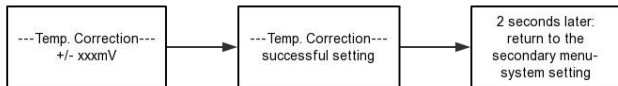

If there is no operation within 3 minutes, it will automatically return to the monitoring page.

5.4. Remote transmission setting

-----Remote Setting-----
➡ 1.RS485
2.Current Transmission

Note:

- RS485 setting: settings of RS485 communication address and baud rate.

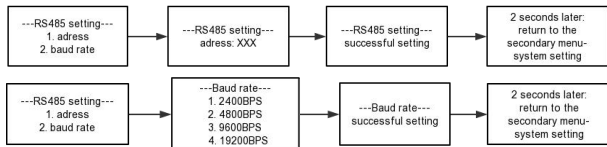

- Current transmission: settings of 4mA corresponding value and 20mA corresponding value of 4-20mA output.

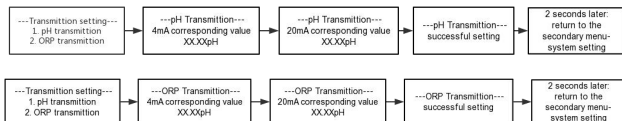

If the button is not pressed for 3 minutes, it will automatically return to the monitoring page.

5.5. Alarm setting

----- Alarm Setting -----

- ➡ 1. PH High Alarm
- 2. PH Low Alarm
- 3. ORP High Alarm
- 4. ORP Low Alarm

Note:

- pH High Alarm: when the measured value is higher than the high reported pull value, the high reported relay pull, when the measured value is less than the high reported off value, the high news relay disconnect.

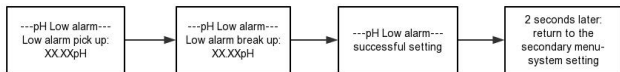

- **pH Low Alarm:** when the measured value is lower than the low pull-in value, the lower newspaper relay pull, when the measured value is higher than the low reported off value, the low alarm relay off.

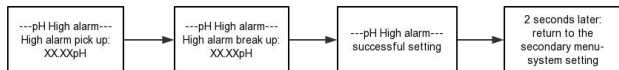

- **ORP High Alarm:** when the measured value is higher than the high reported pull value, the high reported relay pull, when the measured value is less than the high reported off value, the high reported relay disconnect.

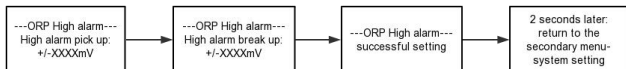

- **ORP Low Alarm:** When the measured value is lower than the low pull-in value, the low relay relays, when the measured value is higher than the low reported off value, the low alarm relay off.



If the button is not pressed for 3 minutes, it will automatically return to the monitoring page.

5.6. Information inquiry

----- Information Inquiry -----
▶ 1. Version Information

Operation:

Hardware:
B-PH2.3-S1

Software:
PH2.3S1V101

- Information inquiry: inquire the current hard software version, high tractability.

If the button is not pressed for 3 minutes, it will automatically return to the monitoring page.

Chapter6 Maintenance

1. The storage of pH glass electrode, short-term: it's stored at the buffered solution of pH=4; long-term: it's stored at the buffered solution of pH=7.
2. Due to contamination possibly lengthen the response time of the measurement , By cleaning of the tip of glass electrode bulbs of the pH sensor. CCl₄ or soap solution can be used to wipe the dirt, then it can be continued to use after being soaked in the distilled water for a whole night. It can be soaked for 10~20 minutes by 5% HF solution when the contamination is serious, then immediately use water to wash clean, finally It's used after being soaked in the 0.1mol/L HCl solution for a whole night.
3. Treatment of glass electrode aging: the aging of glass electrode is related to the progressive change of the substratum structure. The response of the old electrode is slow, the membrane resistance is high, and the slope is low. The external substratum is etched by HF, which can usually improve the electrode performance. If the internal and external substratum can be regularly cleaned by this method, the service life of the electrode is almost unlimited.
4. The best storage solution for the storage Ag-AgCl electrode of the reference electrode is saturation KCl solution, the high concentration KCl solution can prevent the AgCl from being deposited at the solution border and keep the solution border at the working condition. This method can also be used for the storage of combined electrode.

5. The problems of regenerated reference electrode are mostly caused by the blocking of solution border, which can be solved by the following methods:
- (1) Solution border is soaked: the mixed liquid of 10% saturation KCl solution and 90% distilled water is heated to 60~70°C, the electrode is soaked for about 5cm, it's soaked for 20 minutes to 1 hour. This method can eliminate the crystal at the electrode terminal.
 - (2) Soaked by ammonia: the stronger $\text{NH}_3 \cdot \text{H}_2\text{O}$ can be used to eliminate when the solution border is blocked by AgCl. The specific method is to wash clean the electrode, then it's soaked for 10~20 minutes in $\text{NH}_3 \cdot \text{H}_2\text{O}$ after the solution is evacuated, but the $\text{NH}_3 \cdot \text{H}_2\text{O}$ can't enter the internal part of the electrode. The electrode is picked out and washed clean by distilled water, which can be continued to use by adding internal solution.
 - (3) Vacuum method: use soft tube to cover the solution border of the reference electrode, use pump to suck the internal solution until penetrate the solution border, and then the mechanical blocking materials are removed.
 - (4) Solution border is boiled: the solution border of Ag-AgCl reference electrode is soaked in boiled water for 10~20 seconds. Notice that the electrode shall be cooled to room temperature before the next boiling.
 - (5) The mechanical method of abrasive paper can be adopted to eliminate the blocking when the above mentioned methods are invalid, this method possibly blocks the ground sand grains into the solution border and cause permanent blocking.

Chapter7 Troubleshooting

The user must read this manual carefully before installation and use. The instrument should be operated correctly in accordance with the contents of this manual to confirm whether the installation and use environment meets the requirements. The following table is the possible faults encountered by the pH / ORP controller. The user can eliminate the problems according to the troubles.

Problems	Solutions
The signal data is displayed incorrectly or displays "---"	Wiring error: please check whether the input signal cable is connected correctly
	Range exceeded: the measured value exceeds the range
No display on LCD	Please make sure that the power supply wiring is correct and the power supply can supply power normally
The values jumps up and down	Check whether there are interference devices such as inverters around, pay attention to stay away from these interference devices or do shielding measures
The controller cannot be	The standard solution is incorrectly

calibrated	prepared or the electrode is damaged
The instrument can not measure accurately after calibration with a standard solution of pH4.00、pH6.86、pH9.18	The standard solution may be contaminated, please replace the standard solution to re-calibrate
Value response is slow	The electrode bulb may be covered by dirt, and the reaction will be slow. Please clean it according to the type of pollutant. The slow reaction rate in winter is a normal phenomenon